

The SL2100 Quick Install Guide: Terminals Type A (4w)

Out of the
box
installations
for resellers

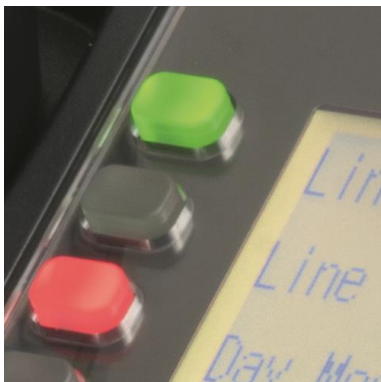
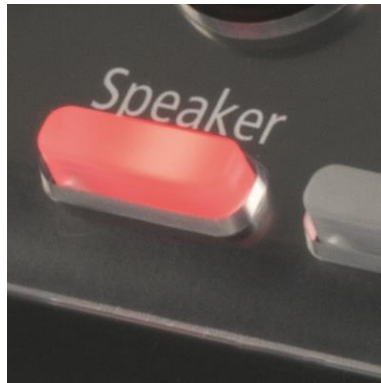

This guide explains the installation, configuration and operation of the SL2100 Type B Terminals (2 wire) including the audio and relay connections of the interface card.

Further information is available on BusinessNet.

Please keep all information supplied for future reference.

Regulatory Notice.

Refer to the Declaration of Conformity, Regulatory and Safety Considerations shown in the SL2100 Hardware Manual.

Warning: This is a class A product. In a domestic environment this product may cause radio interference in which case the user may be required to take adequate measures.

Contents

Digital Type A Terminals	4
Parts available for the SL2100	5
IP7WW-308U-A1 / IP7WW-008U-C1 Interface Card	6
1- Unpack the IP7WW-308U-A1 / IP7WW-008U-C1 Card	7
2- Install the IP7WW-308U-A1 / IP7WW-008U-C1 Card	8
3- Connect the Telephones	9
Connecting to the RJ45 sockets of the IP7WW-308U-A1 & IP7WW-008U-C1 card	9
Terminating extensions at RJ11 or RJ45 face plates at the user's desk.	11
4- Connect DSS Consoles	12
5- Connect Doorphones	12
6- Connect External Sensors	14
7- Connect the Power & System Start Up	15
8- Configure the SL2100	16
Connecting PCPro to the SL2100	16
SL2100 PCPro.....	17
Port Assignment of the IP7WW-308U-A1 and IP7WW-008U-C1 card	18
DSS Console and Operator.....	19
Operator Extension	20
Analogue Extensions.....	21
Timed Break Recall (TBR) / Hook Flash	24
Doorphones and Door Lock Relay Contacts	25
What to do if you make errors within the SL2100 Configuration	26

Digital Type A Terminals

The SL2100 system consists of a chassis unit that supports the installation of either Type A or Type B digital terminals, as only one terminal type can be installed there are separate Quick Install Guides for each.

This guide details the installation of Type A terminals.



Refer to the following Quick Install Guide for other terminals:

- Quick Install Guide – Digital Terminals Type B
- Quick Install Guide – IP Terminal 8IPLD
- Quick Install Guide – IP Terminals DT820



Digital Terminal	Connect to interface card	Terminal wiring
Type A	IP7WW-308U-A1 or IP7WW-008U-C1	4 wire connection
Type B	IP7WW-082U-B1	2 wire connection

SL2100 Type A Digital Terminals

	12 Button	24 Button	60 Button DSS
			
Part code & description	BE116513 IP7WW-12TXH-A1 TEL	BE116514 IP7WW-24TXH-A1 TEL	BE116518 IP7WW-60D-A1 CONSOLE
Connected to	Hybrid Extension Port		
Power feeding	From hybrid extension port		
Colour	Black		
Display	16 digits x 2 lines without backlight		None
Programmable keys	12 (red/green)	24 (red/green)	60 (red/green)
Soft keys	None		
Menu curser keys	Yes		No
Incoming call lamp	Yes (red/green)		No
Handsfree	Yes (half duplex)		No
Backlit dial pad	No		
Headset Port	No (use handset RJ11 connector)		No
EHS support	No		
Angle Adjustment	Yes (2 steps)		
Wall Mounting	Yes (built in)		

Parts available for the SL2100

Not all parts are included within this guide, please refer to the other SL2100 Quick Install Guides or the SL2100 Hardware Manual for a full description and installation instructions of all parts available.

IP7WW-4KSU-C1	SL1100 Chassis unit	
IP7EU-CPU-C1	SL2100 CPU card	
IP7EU-CPU-C1-A	SL2100 CPU card with pre-installed IP licenses and 2hour InMail	
IP7WW-308U-A1	3 Analogue trunks and 8 Hybrid Extensions card for digital (4wire) extensions or SLT extension	3 Analogue trunks and 8 digital or SLT extension interfaces, max 4 per unit
IP7WW-008U-C1	8 Hybrid Extensions card for digital (4wire) extensions or SLT extension	8 digital or SLT extension interfaces, max 4 per unit
IP7WW-12TXH-A1 TEL (BK)	12 Keys, Digital (4W) Multiline Terminal (Black)	
IP7WW-24TXH-A1 TEL (BK)	24 Keys, Digital (4W) Multiline Terminal (Black)	
IP7WW-60D DSS-A1 CONSOLE (BK)	60 Keys, Digital (4W) DSS Console (Black)	
DX4NA Doorphone	Doorphone	

Refer to Prophix for all parts and licenses available in your region.

IP7WW-308U-A1 / IP7WW-008U-C1 Interface Card

Type A terminals can be connected to either the IP7WW-308U-A1 or the IP7WW-008U-C1 cards. SL2100 chassis showing the CPU card with an extension interface card installed.

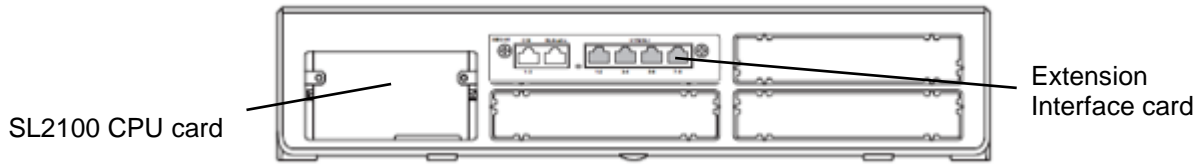

	IP7WW-308U-A1	IP7WW-008U-C1
Analogue trunks	3	0
Hybrid extensions	8	8
External Music/BGM input	1	0
External Paging output	1	0
Relay contacts	2	0
Trunk daughter card supported	No	Yes

The cards can be installed into any of the universal slots S1~S4.

Note – Slot S4 does not support digital extensions, an IP7WW-308U-A1 or IP7WW-008U-C1 card can be installed but will only support analogue extensions.

SL2100 Capacity

Item	Maximum capacity in a single chassis	
TDM Trunks	42	There is a trade-off between each trunk type, see below
Analogue	12	
ISDN BRI	16	
ISDN PRI	30	
TDM Extensions	32	There is no trade-off between each extension type as each hybrid extension port supports either a digital or analogue SLT terminal
Analogue SLT	32	
Digital	24	
Maximum IP	176	IP capacity is independent of the TDM capacity
IP Trunks	64	
IP Extensions	112	
External Music on Hold	1	
External Background Music	1	
External Paging	3	
Relays	6	

Trade-off between TDM trunk interfaces (for simplicity does not include PRI trunks, Refer to the Quick Install Guide for PRI trunk capacity).

SL2100 Trunk capacity for a single chassis

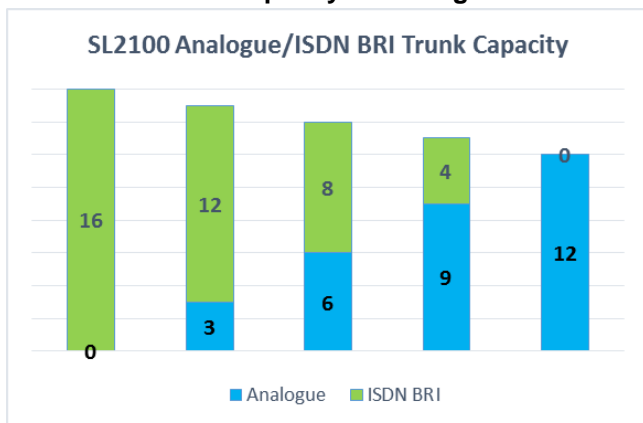

SL2100 Extension capacity for a single chassis

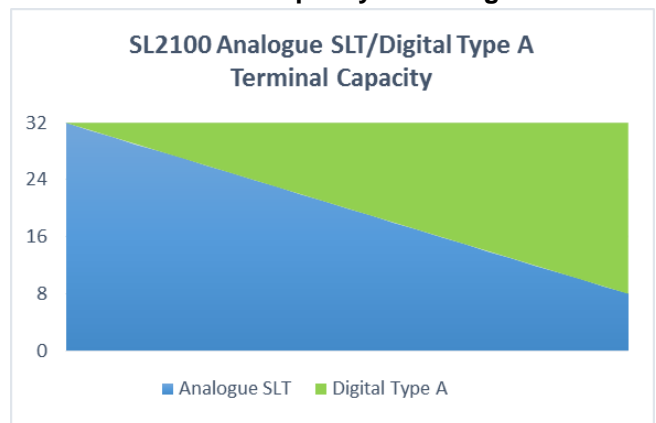

1- Unpack the IP7WW-308U-A1 / IP7WW-008U-C1 Card

SL2100 Extension Interface card

1 x Interface card

Additional Items Required:

- Cross head screwdriver.
- Utility knife or small cutters to remove the plastic knockouts
- Solid wire for extending telephone cabling:
 - Recommended cable type: Twisted pair (CW1308 or similar specification)
 - Conductor diameter: 0.4 to 0.6 mm
 - Maximum cable length: (with 0.5 mm diameter cable)
 - SL2100 system telephone – 300 metres
 - Normal telephone (SLT) – 1125 metres

2- Install the IP7WW-308U-A1 / IP7WW-008U-C1 Card

The SL2100 chassis does not have any cards pre-installed, you install the extension interface card of your choice.

! Ensure the SL2100 is powered off before removing/installing any card.

You may also have a trunk daughter card to mount onto the IP7WW-008U-C1 card, refer to the Quick Install Guide for the trunk card type for installation details.

The following trunk daughter cards may be mounted

IP7WW-3COIDB-C1	3 Analogue trunks
IP7WW-2BRIDB-C1	2 ISDN BRI circuits (4 trunk channels)
IP7WW-1PRIDB-C1	1 ISDN PRI circuit (30 trunk channels)

Each IP7WW-008U-C1 card can have one daughter card mounted.

If you are connecting a doorphone unit then you must set the hardware links on the IP7WW-308U-A1 card before installing into the chassis, refer to the Doorphone section later in this guide.

Note – Slot 4 does not support digital extensions, an IP7WW-308U-A1 or IP7WW-008U-C1 card can be installed but will only support analogue extensions, any trunk daughter card is supported in slot 4.

Remove the plastic knockout from the slot on the front of the SL2100 chassis.

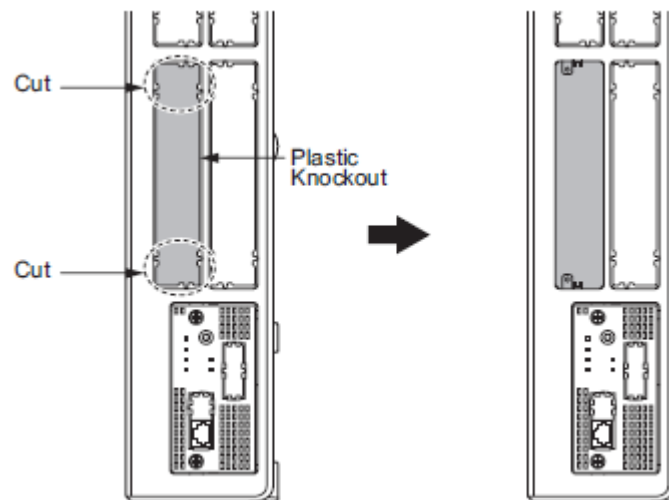

Note – the knockout can not be replaced once removed; there are no blanking covers available, be sure to remove the correct knockout.

Insert the interface card into the SL2100 universal slot, ensure the card slides into the guide rails and tighten the two screws to secure the card.

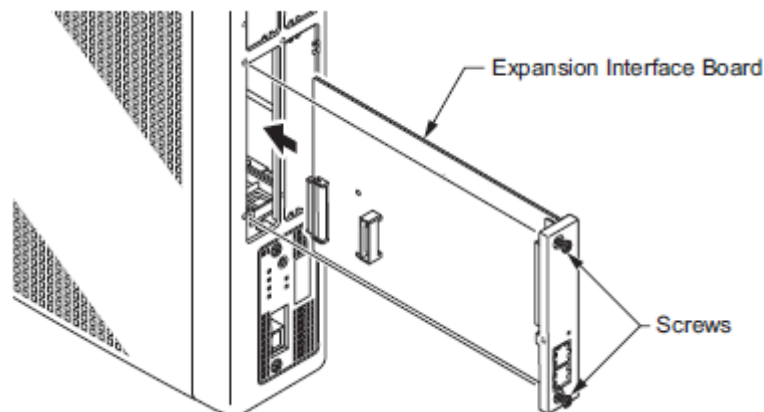

3- Connect the Telephones

The connectors of the IP7WW-308U-A1 and IP7WW-008U-C1 cards have multiple extension ports per RJ45 connector using the RJ61 pin-out format.

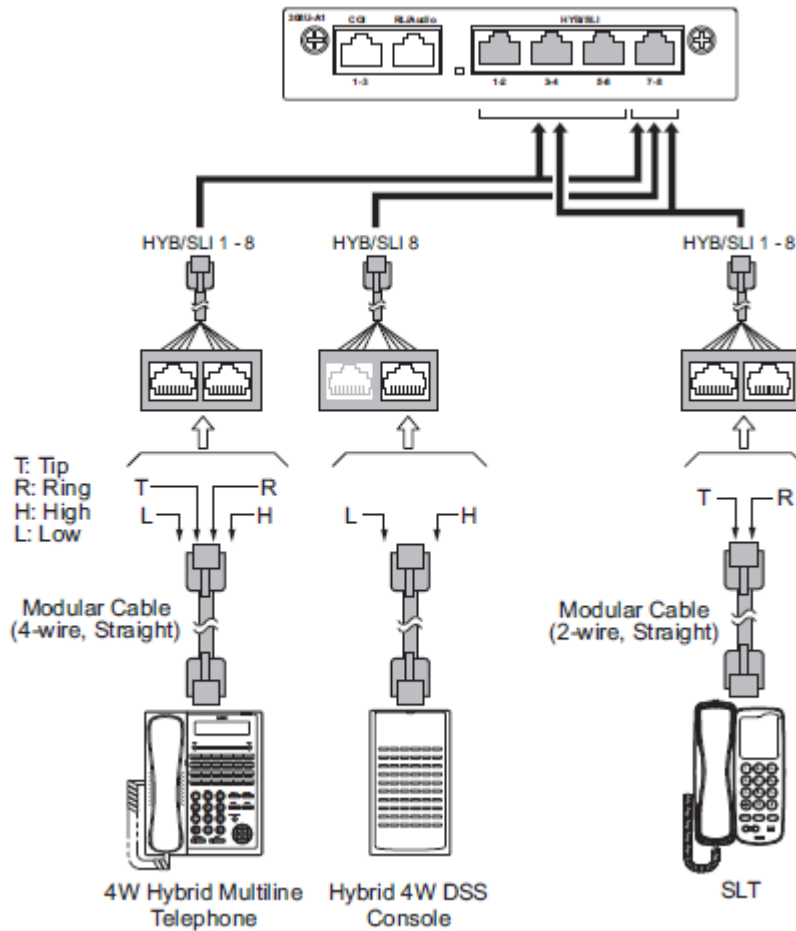

The SL2100 will automatically detected the terminal type when the device is connected.

Connecting to the RJ45 sockets of the IP7WW-308U-A1 & IP7WW-008U-C1 card

There are several methods available to connect these interfaces into the customer's building infrastructure.

1. Use the cable assembly or adapter available from NEC

Cable LPNEC2 – 2m length, converts a two port RJ45 socket to two RJ45 plugs, one port per plug.

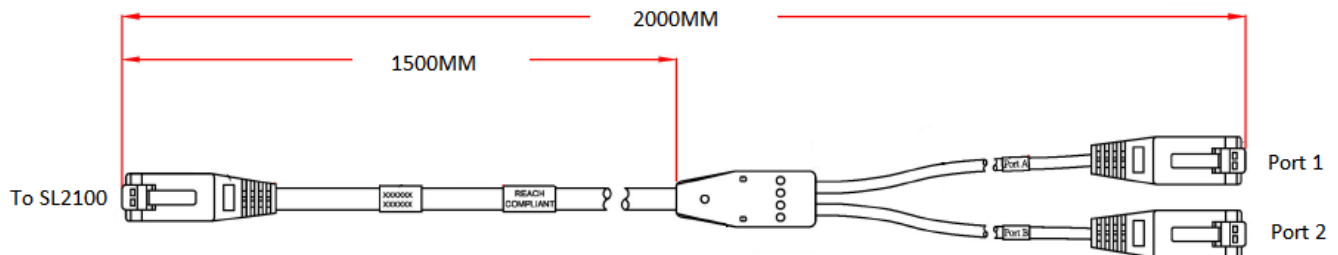

Can be used to connect into an RJ45 through coupler panel or directly into the customer's panels.

Can also be used to plug into RJ45 face plates if IDC termination is required.

Cable colour: black

One cable is required for each HYB/SLI socket of the IP7WW-308U-A1 or IP7WW-008U-C1 card.

Ports 1~2 RJ45 plug	
Pin	
1	-
2	-
3	H
4	R
5	T
6	L
7	-
8	-

Adapter ADNEC24 – Converts 2 x two port RJ45 sockets to four RJ45 sockets, one port per socket.
 Requires six patch cables of the desired length and colour.
 Can be used to connect into an RJ45 through coupler panel or directly into the customer's panels.
 Can also be used to plug into RJ45 face plates if IDC termination is required.
 Colour: black.
 Supplied with an adhesive pad.
 One adapter will convert two RJ45 sockets of the IP7WW-308U-A1 or IP7WW-008U-C1 card.

Ports 1~4 RJ45 sockets	
Pin	
1	-
2	-
3	H
4	R
5	T
6	L
7	-
8	-

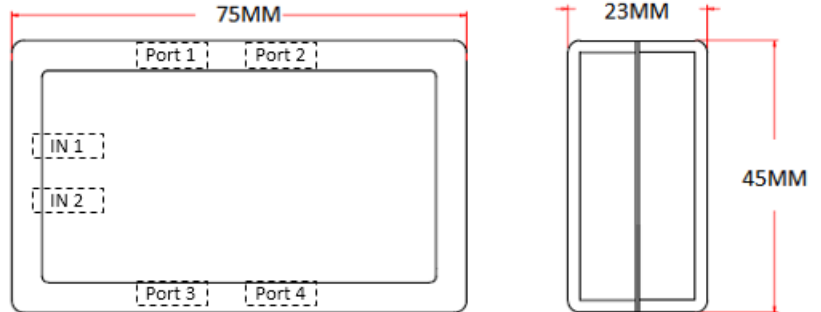

2. Terminate cables on site with RJ45 plugs and connect directly to the RJ45 sockets of the card.
 Use the following pin-out to terminate each RJ45 plug.

HYB/SLI 1~2, 3~4, 5~6, 7~8	Pin No.	Port
 87654321	1	2H
	2	1H
	3	2T
	4	1R
	5	1T
	6	2R
	7	1L
	8	2L

3. Use pre-terminated RJ45 patch cables and connect directly to the RJ45 sockets of the card.
 Use the following cable colours when using a straight through RJ45 patch cable directly into the RJ61 sockets of the card.

HYB/SLI 1~2, 3~4, 5~6, 7~8	Pin No.	Port	Using an RJ45 patch cable into the RJ45 connectors
			RJ45 Colour code
 87654321	1	2H	White/Orange
	2	1H	Orange/White
	3	2T	White/Green
	4	1R	Blue/White
	5	1T	White/Blue
	6	2R	Green/White
	7	1L	White/Brown
	8	2L	Brown/White

Terminating extensions at RJ11 or RJ45 face plates at the user's desk.

Each port connects to

RJ11 = Connections 3/4 2/5

RJ11 Face plate	
Pin	Connection
1	-
2	H
3	R
4	T
5	L
6	-

RJ45 = Blue/White & Green/White connections

RJ45 Face plate	
Pin	Connection
1	-
2	-
3	H
4	R
5	T
6	L
7	-
8	-

4- Connect DSS Consoles

One DSS consoles can be connected to hybrid extension port 8 of the IP7WW-308U-A1 or IP7WW-008U-C1 card.

The maximum system capacity is 9 consoles, each chassis can have 3 consoles maximum.

Each DSS console is assigned to a digital extension with PCPro, up to 4 consoles can be assigned to the same extension.

DSS consoles use only 2 wires when connecting to the SL2100.

Connect to pins H & L.

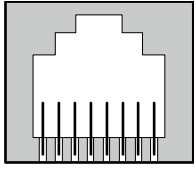
HYB/SLI 7~8	Pin No.	Port
 87654321	1	2H
	2	
	3	
	4	
	5	
	6	
	7	
	8	2L

5- Connect Doorphones

Up to two doorphones (BE109741 – DX7NA) can be connected to hybrid extension ports 6 & 7 of the IP7WW-308U-A1 card.

The maximum system capacity is 6 doorphones.

Hybrid extension ports 6 & 7 of the IP7WW-308U-A1 card has hardware links to select SLT/doorphone operation.

The factory setting is SLT operation.

Ensure you set the hardware links as shown.

The hardware links set the mode, there is no additional system configuration required to select SLT/doorphone operation

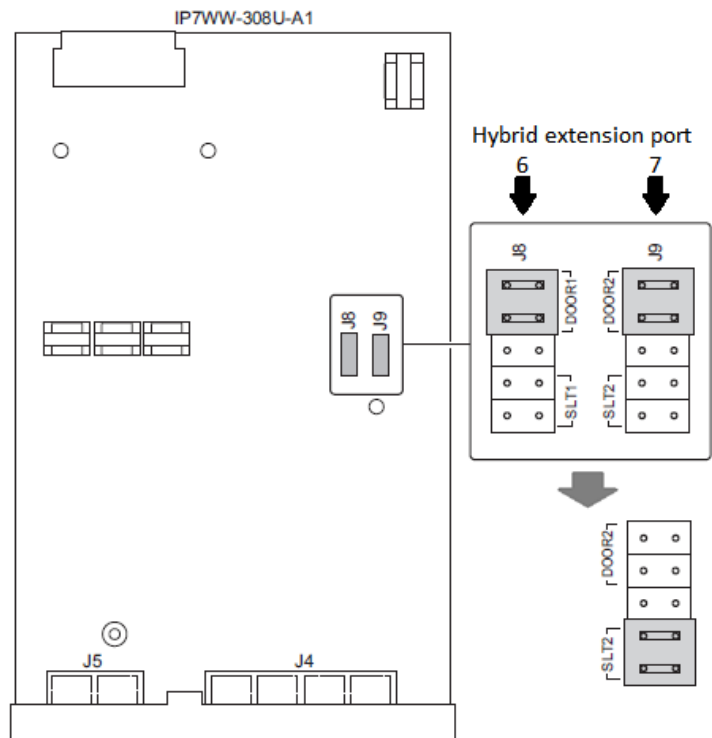

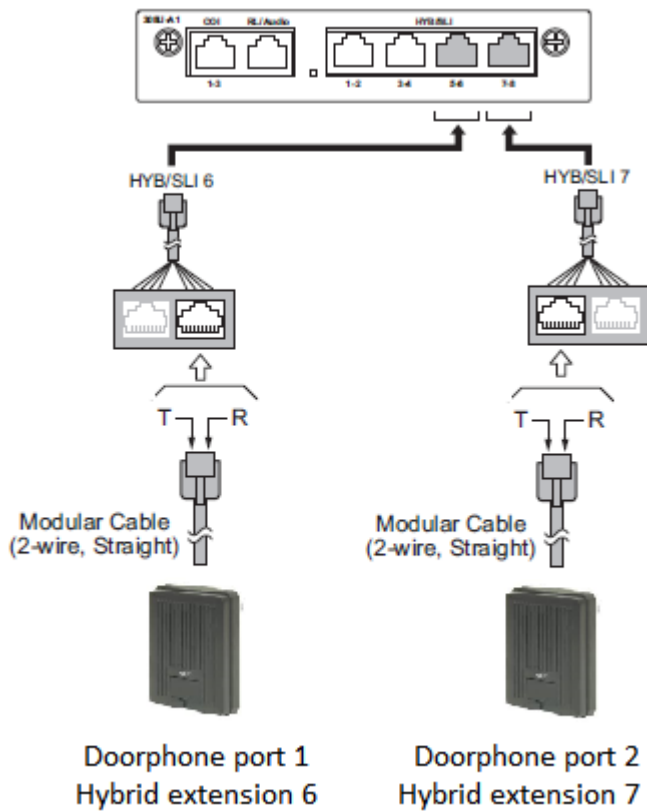

Terminating at the **doorphone**

Each port connects to: & at the doorphone. The connections to the doorphone are none polarity.

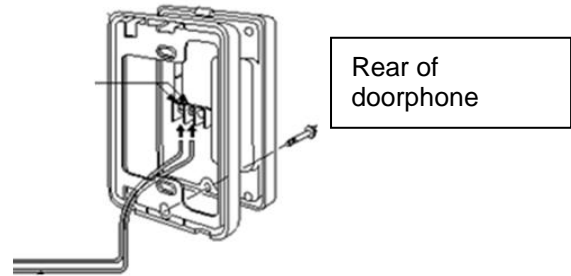

HYB/SLI 5~6, 7~8	Pin	HYB/SLI 5~6 Port 6	HYB/SLI 7~8 Port 7
<p>87654321</p>	1	-	-
	2	-	-
	3	Door 1 T	-
	4	-	Door 2 R
	5	-	Door 2 T
	6	Door 1 R	-
	7	-	-
	8	-	-

6- Connect External Sensors

The SL2100 can be used to detect the operation of external sensors by connecting to the analogue extension port that is set to doorphone mode.

The external sensor can be any normally open contact (Form A) for example, push button/panic switch or PIR detector with a suitable specification.

When the external sensor is closed/activated the SL2100 system will ring a group of extensions in the same way as the doorphone would.

Pin	HYB/SLI 5~6 Port 6	HYB/SLI 7~8 Port 7
1	-	-
2	-	-
3	Door / sensor 1 T	-
4	-	Door / sensor 2 R
5	-	Door / sensor 2 T
6	Door / sensor 1 R	-
7	-	-
8	-	-

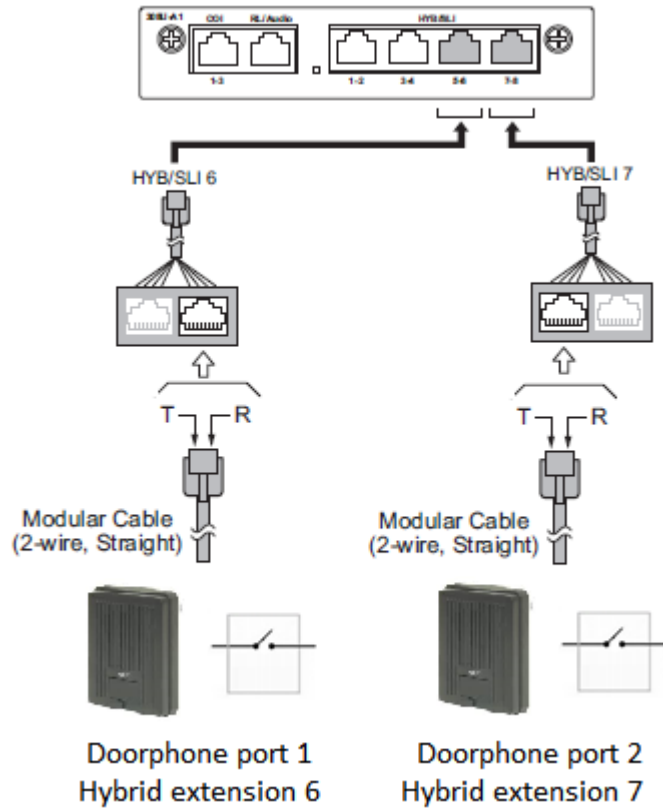

Description	Specification
External sensor	Voltage during sensor off (contact open): 25V Loop current during sensor on/activated (contact closed) : 40mA

7- Connect the Power & System Start Up

The power cable is plugged into the left side (wall mounted) or rear (when rack mounted) of the unit via an IEC-C13 connector.

Before connecting the power:

- Ensure the power switch is OFF
- Ensure the power is switched off at the source
- All cards are installed and secured correctly

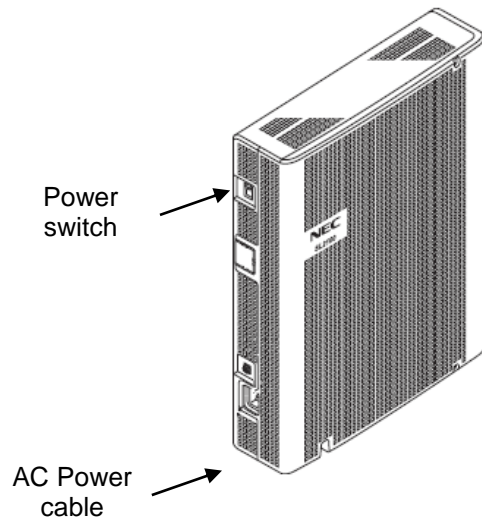

System Start Up – First Time

! The first time you start up the SL2100 it is important to clear the system memory. This will ensure that the system is set to the default/factory configuration.

1. Push and hold the LOAD Button located on the front of the CPU card.

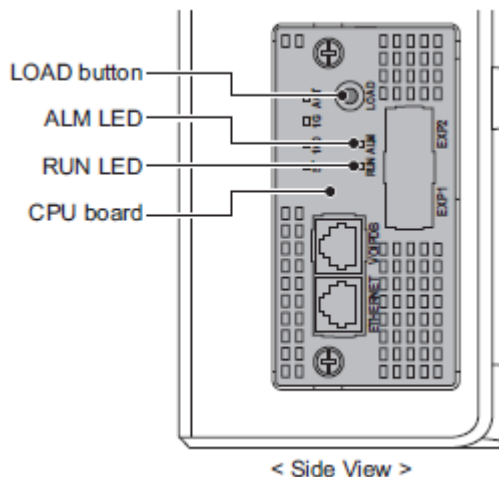

Also referred to as '**COLD Start**' can also be used at any time to delete the customer's configuration.
Warning – COLD Start should only be used when you want to delete the customer's configuration from the SL2100 CPU card.

2. Turn the power switch on
3. Continue holding the LOAD Button for approximately 10 seconds or until the ALM lamp on the CPU card lights.
4. Release the LOAD Button
5. When the system has completed reloading the system software (about one minute) the RUN LED is flashing green on the CPU card and the system phones will display the Time and Date.

Switching the SL2100 OFF

! Be sure that no calls are in progress otherwise they will be cut off.

Turn the power switch OFF at the SL2100 chassis.

System Start Up – Retain Customer Configuration

This is the normal operation for powering the SL2100 on.

Turn the power switch ON at the SL2100 chassis.

Any new installed cards will be automatically detected.

8- Configure the SL2100

This Quick Install guide will cover the most frequently used configuration options. For advanced configuration please refer to the SL2100 Features and Specifications manual.

You must have SL2100 PCPro installed to your laptop/PC, this can be downloaded from BusinessNet, refer to the Quick Install Guide – SL2100 PCpro.

The SL2100 can also be configured via an SL2100 System phone or via a WebPro interface, these are not included within this guide.

Before you configure your system it is important that you:

- Have a diagram of your exchange lines and telephones.
- Plan your requirements before you start.

While you configure your system it is advised that you:

- Make a record of your configuration as you make each change.
- Make small changes, upload to the SL2100 and test the changes. Avoid making all your changes at once as this can make testing more difficult.

With the default/factory settings:

- Each telephone will function and is assigned an extension number (200~211).
- Calls received on the exchange lines will ring at telephone number 200.
- Each telephone can make exchange line calls by dialing 0.
- Each exchange line is presented at a Function Key with busy lamp indication.

Connecting PCPro to the SL2100

CPU Default IP Address:

192.168.0.10 / 255.255.255.0

You can check the IP address at any SL2100 system phone:

Press the centre Navigation Key and dial 841

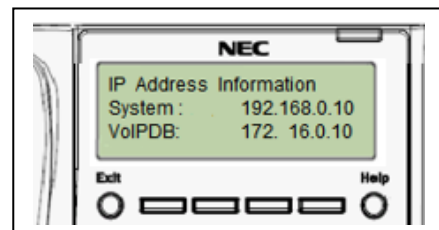

Direct to Ethernet connector on the SL2100 CPU card.



Via the customer's LAN.

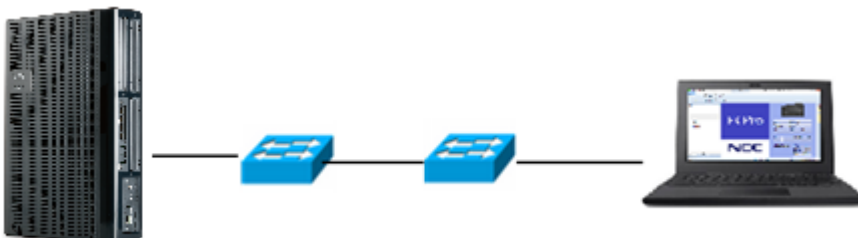

Configure the SL2100

SL2100 PCPro

Installer level access:

User Name: tech

Password: 12345678

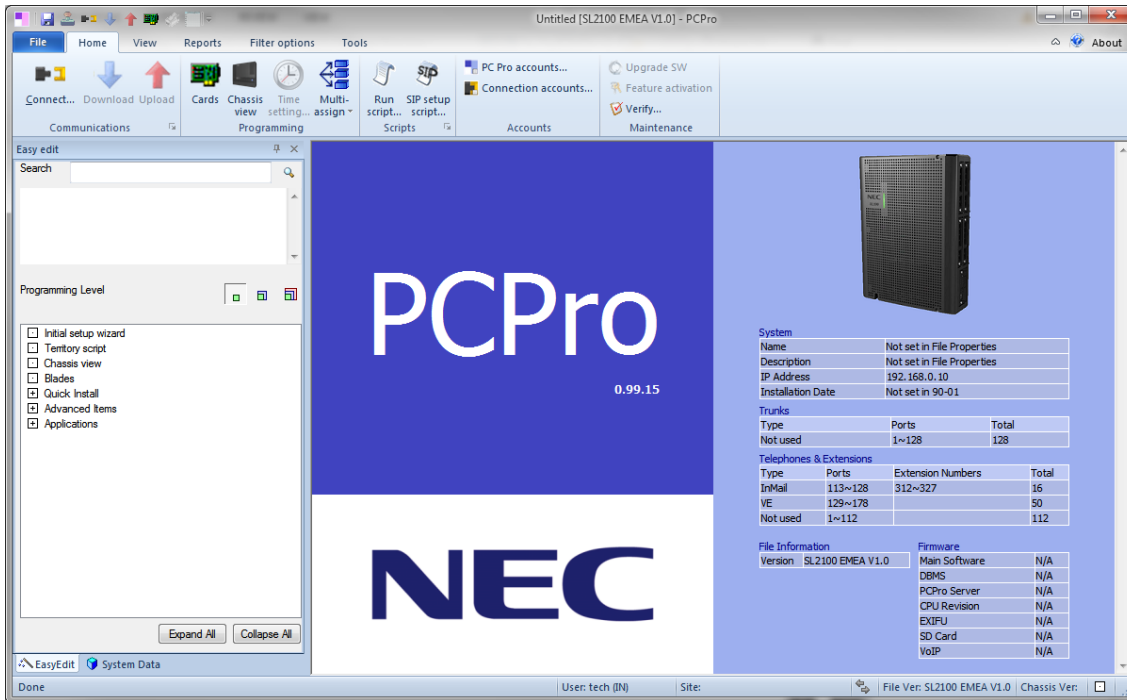
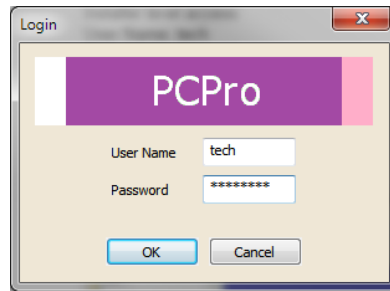

On first install you may need to setup the default sliding panes if you wish to use these. Select **View** tab and click **Default**



Port Assignment of the IP7WW-308U-A1 and IP7WW-008U-C1 card

Go to the Chassis View to confirm the ports assigned to the cards installed within the SL2100 system.

IP7WW-308U-A1 card

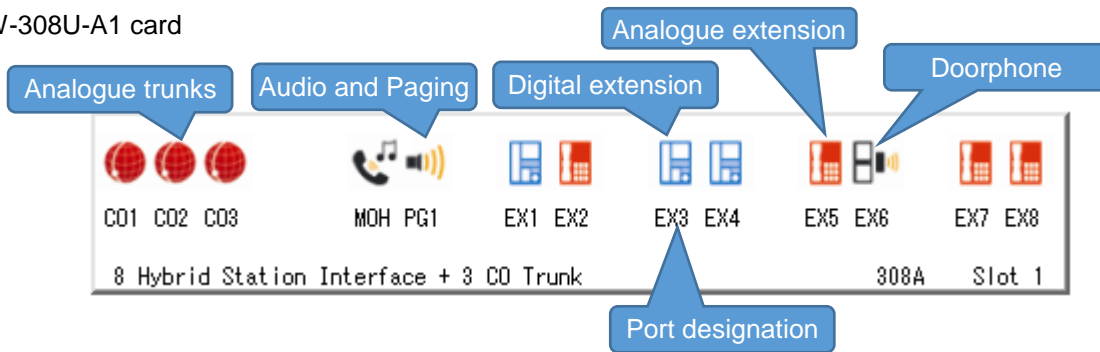

IP7WW-008U-A1 card without any trunk daughter card installed.

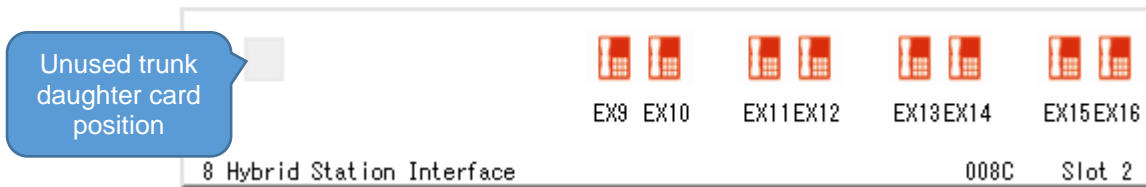

Clicking on any of the interfaces will show the appropriate Properties Pane where you can configure the selected port.

The Properties pane for extension 200 includes the following configuration options:

- Extension: 200
- Name: Reception
- ISDN Calling Party Nu.:
- COS: 1, 1, 1, 1, 1, 1, 1, 1
- Toll Restriction: 2, 2, 2, 2, 2, 2, 2, 2
- Toll Restriction Tables:
 - Toll Tables
 - Toll Common Tables
 - Toll Restriction Tables
 - Toll Permit Tables
 - Toll Prefix codes
- Call forward: No Call Forward
- Call forward No Answer: 10
- Call forward destination:
- SLT type:
- Groups:
 - Department group: 1, 1
 - Pick up group, priority: 1, 1
 - Park hold group: 1

Callouts indicate: 'Edit each item within the Properties pane' and 'Click the Extension button to open the Easy Edit screen to edit all extension names and numbers'.

Station Port	Extension	Name
001	200	
002	201	
003	202	
004	203	
005	204	
006	205	
007	206	
008	207	
009	208	

DSS Console and Operator

One DSS consoles can be connected to hybrid extension port 8 of the IP7WW-308U-A1 or IP7WW-008U-C1 card.

The SL2100 will automatically detect the DSS console when it's connected.

1. Go to the Chassis View and click the DSS console.
2. Assign the console to the extension that it will be used with
3. Setup the keys of the DSS console

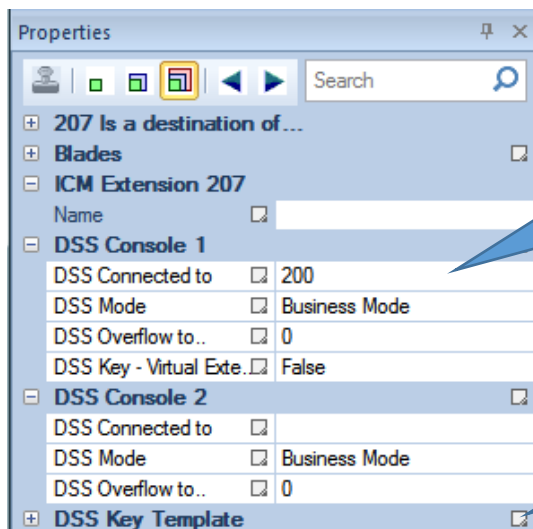

Enter the extension that the console will be used with

Click to setup the DSS console's keys

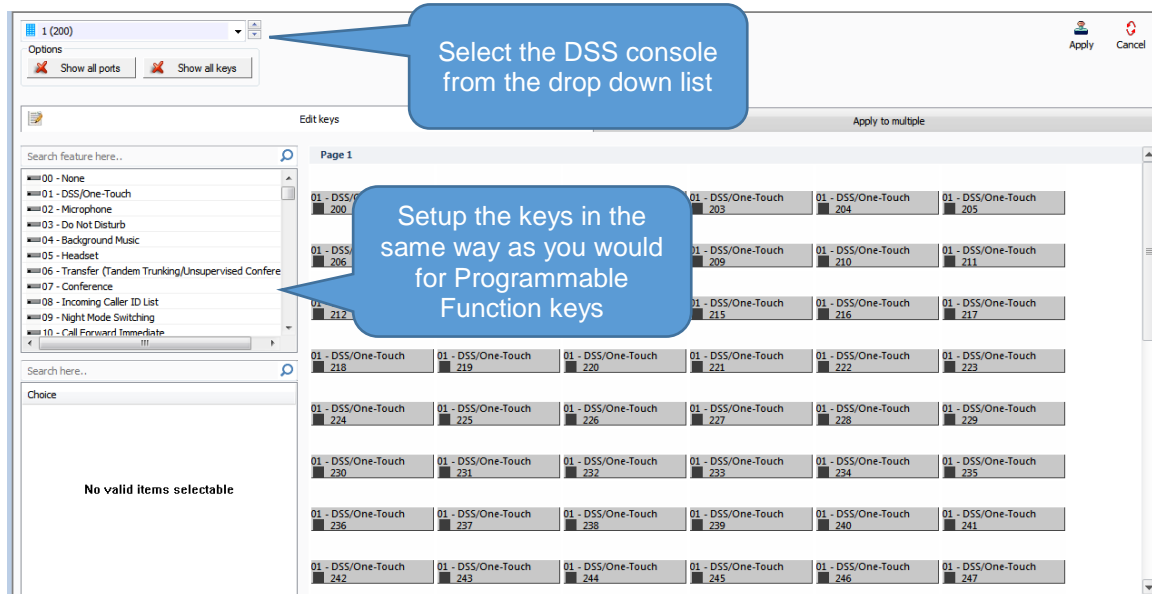

Select the DSS console from the drop down list

Setup the keys in the same way as you would for Programmable Function keys

Operator Extension

The Operator pilot number (usually 0 or 9) is setup within the PCPro Initial Setup wizard.

You can check/edit the Operator number within Easy Edit-System Numbering Plan-System Numbering (you will need to select level 3 details view).

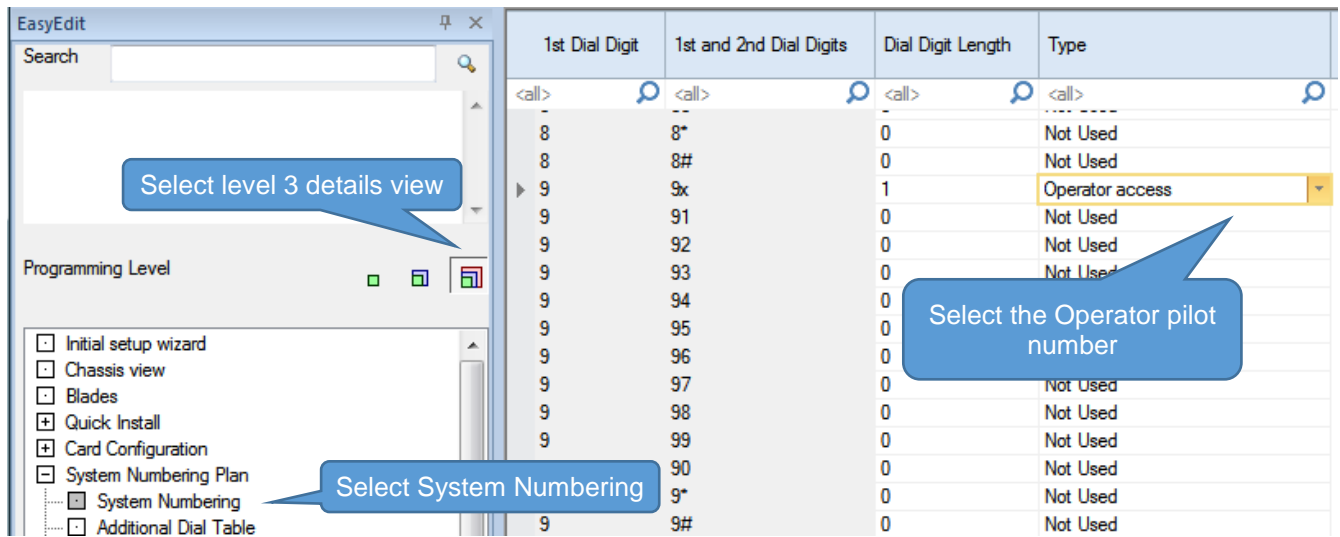

The Operator extension that is the target of the pilot number is defined in Easy Edit-System Numbering-Default Operator

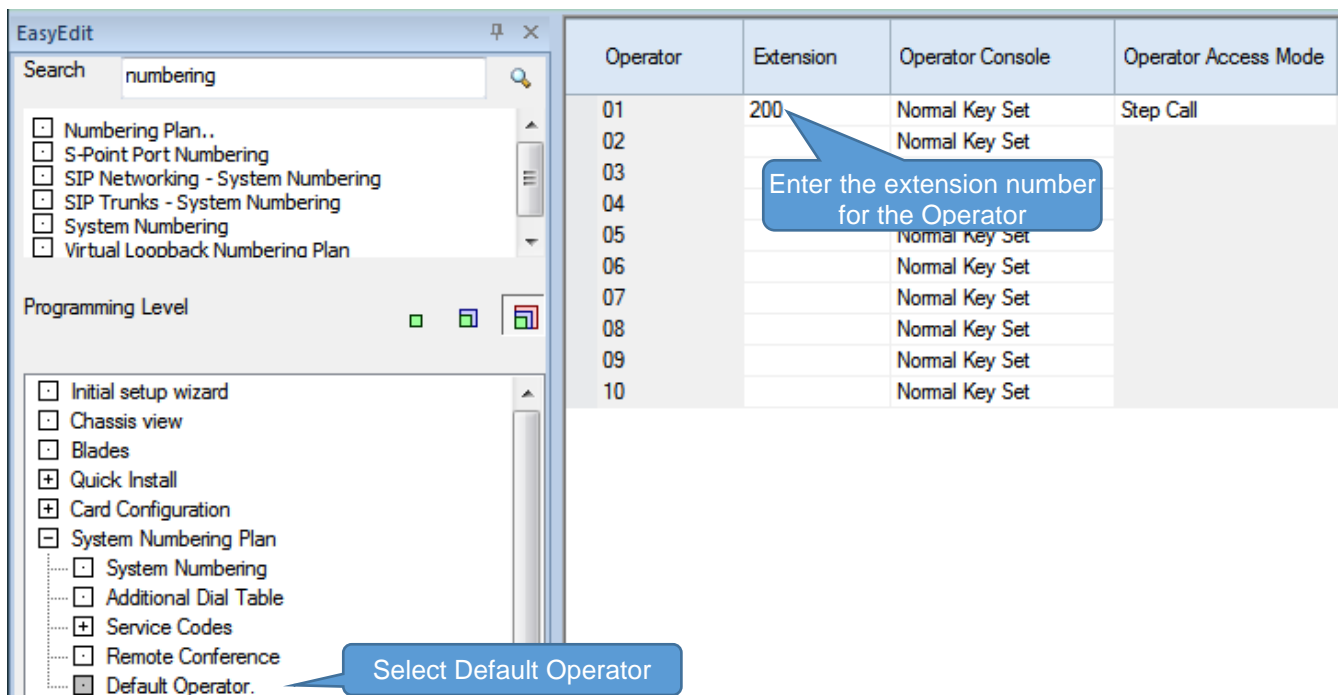

Analogue Extensions

Timers for analogue extensions are setup in Easy Edit-Extensions-Extension-Single Line Tele[hone SLT-SLT Data Setup

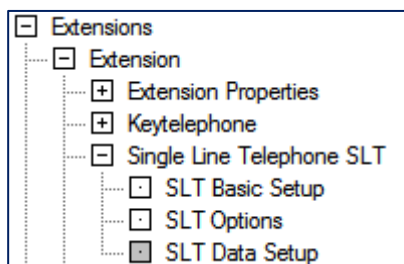

The following timers are available.

Companding Method Type	A-law
Ringing Frequency	25Hz
Minimum Break Time	2
Maximum Break Time	10
Minimum Make Time	2
Maximum Make Time	20
Minimum Hook-flash Time	10
Maximum Hook-flash Time	20
Minimum Ground-flash Time	21
Minimum Off-hook Time	19
No Detection Time after Off-hook	60
No Detection Time after Pulse Dial Detection	70
Loop Disconnect Time after Reversal Time	60
Ring Message Wait Period	150

These are not timers and should be set as follows:

- **Companding Method Type** - Select the codec type for the SLT - A law or u-law
Set this to A-Law
- **Ringing Frequency** - Select the ringing frequency, 25Hz, 20Hz or 16Hz.
Set this to 25Hz

Calculating the timer setting

Description	Setting	Timer setting
Minimum Break Time	1~255	5~1275mS [5mS increment]
Maximum Break Time	1~255	5~1275mS [5mS increment]
Minimum Make Time	1~255	5~1275mS [5mS increment]
Maximum Make Time	1~255	5~1275mS [5mS increment]
Minimum Hook Flash Time	1~255	5~1275mS [5mS increment]
Maximum Hook Flash Time	1~255	5~1275mS [5mS increment]
Minimum Ground-flash Time	1~255	5~1275mS [5mS increment]
Minimum Off-hook Time	1~255	5~1275mS [5mS increment]
No Detection Time after Off-hook	1~255	5~1275mS [5mS increment]
No Detection Time after Pulse Dial Detection	1~255	5~1275mS [5mS increment]
Loop Disconnect Time after Reversal Time	1~255	10~2550mS [10mS increment]
Ring Message Wait Period	1~255	5~1275mS [5mS increment]

Default Timer Setting

Description	Function	Default	
Minimum Break Time	The minimum duration of a dial pulse break	2 (10mS)	
Maximum Break Time	The maximum duration of a dial pulse break	10 (50mS)	For Time Break Recall detection set this timer to 13 (65mS). Do not set this item to less than 13 (65mS)
Minimum Make Time	The minimum duration of a dial pulse make	2 (10mS)	
Maximum Make Time	The maximum duration of a dial pulse make	20 (100mS)	
Minimum Hook Flash Time	The minimum duration of a Hook Flash/Time Break Recall TBR	10 (100mS)	For Time Break Recall detection set this timer to 14 (70mS).
Maximum Hook Flash Time	The maximum duration of a Hook Flash/Time Break Recall TBR	20 (100mS)	For Time Break Recall detection set this timer to 25 (125mS)
Minimum Ground-flash Time	The minimum duration of a ground flash	21 (105mS)	
Minimum Off-hook Time	The minimum time for an off-hook duration	19 (95mS)	
No Detection Time after Off-hook	The duration after off-hook before dialling will be accepted	60 (300mS)	
No Detection Time after Pulse Dial Detection	The maximum duration after each pulse	70 (350mS)	
Loop Disconnect Time after Reversal Time	The time after line reversal that a Loop Disconnect is recognised	60 (600mS)	
Ring Message Wait Period		150 (750mS)	

Recommended Timer Setting

Description	Setting	
Minimum Break Time	2 (10mS)	
Maximum Break Time	13 (65mS)	For Time Break Recall detection
Minimum Make Time	2 (10mS)	
Maximum Make Time	20 (100mS)	
Minimum Hook Flash Time	14 (70mS)	For Time Break Recall detection
Maximum Hook Flash Time	25 (125mS)	For Time Break Recall detection
Minimum Ground-flash Time	21 (105mS)	
Minimum Off-hook Time	19 (95mS)	
No Detection Time after Off-hook	60 (300mS)	
No Detection Time after Pulse Dial Detection	70 (350mS)	
Loop Disconnect Time after Reversal Time	60 (600mS)	
Ring Message Wait Period	150 (750mS)	

Dial Pulse

The signalling type can be setup for each SLT port within PCPro Easy Edit – Extensions – Extension – Single Line Telephone SLT – SLT Basic Setup.

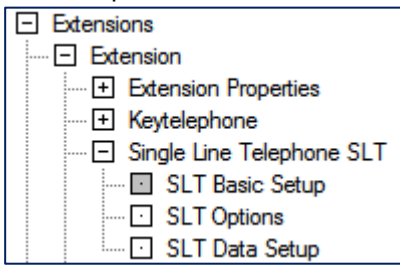

Station Port	Extension	Name	Signaling Type
▶ 010	209	Extn 209	DP
011	210	Extn 210	DTMF

Signalling type for SLT's: DTMF or DP

Dial Pulse telephones are usually 10pps (pulses per second) with a break period of 66mS & make period of 34mS.

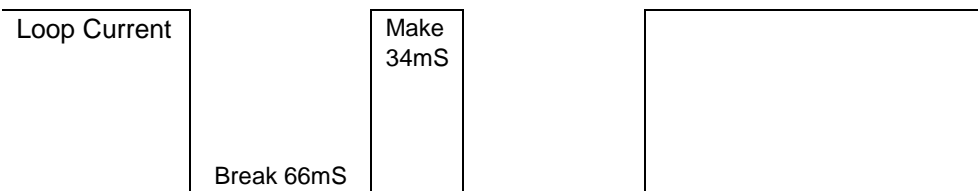

The default settings of the SL2100 will detect a break period between 10~100mS and a make period of 10~50mS.

Description	Function	Default	
Minimum Break Time	The minimum duration of a dial pulse break	2 (10mS)	
Maximum Break Time	The maximum duration of a dial pulse break	10 (50mS)	Set to 13 (65mS) when TBR is required
Minimum Make Time	The minimum duration of a dial pulse make	2 (10mS)	
Maximum Make Time	The maximum duration of a dial pulse make	20 (100mS)	

Note – The setting of the Maximum Break Time is reduced to 13 (65mS) to allow the detection of Timed Break Recall (TBR).

Note - You must set the Maximum Break Time for Dial Pulse to a value less than that of the Minimum Hook Flash Time otherwise the system will not detect Timed Break Recall.

Timed Break Recall (TBR) / Hook Flash

Timed Break Recall / Hook Flash is used by an SLT to signal to the SL2100 that secondary dial tone is required, for example to place the call on hold and dial another number when transferring a call.

The TBR button on an SLT is usually marked with **R** or **Recall** Note, some telephones may have the button marked with **FLASH**.

Hook Flash is not used in the EU and is usually a break period of greater than 500mS.

Timed Break Recall is typically 90~120mS, so the SL2100 must be setup to detect outside of this range.

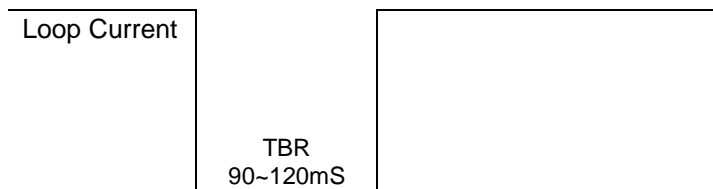

The typical setting for the SL2100 is to detect a TBR within a 70~125mS period.

Description	Function	Setting	
Maximum Break Time	The maximum duration of a dial pulse break	13 (65mS)	For Time Break Recall detection set this timer to 13 (65mS).
Minimum Hook Flash Time	The minimum duration of a Hook Flash/Time Break Recall TBR	14 (70mS)	For Time Break Recall detection set this timer to 14 (70mS).
Maximum Hook Flash Time	The maximum duration of a Hook Flash/Time Break Recall TBR	25 (125mS)	For Time Break Recall detection set this timer to 25 (125mS)

Note – You must also set the Maximum Break Time for Dial Pulse to a value less than that of the Minimum Hook Flash Time otherwise the SL2100 will not detect TBR.

Ground Flash Recall (Earth Loop Recall)

Ground Flash Recall is not covered in this guide.

It is not recommended that you change these timers from default.

Minimum Ground-flash Time	21 (105mS)
----------------------------------	------------

Off Hook Detection Time

These timers determine the duration the phone must be off hook before the SL1100 will begin sending dial tone.

It is not recommended that you change these timers from default.

Description	Function	Default
Minimum Off-hook Time	The minimum time for an off-hook duration	19 (95mS)
No Detection Time after Off-hook	The duration after off-hook before dialling will be accepted	60 (300mS)

Loop Disconnect Time after Reversal

It is not recommended that you change this timer from default.

Loop Disconnect Time after Reversal Time	60 (600mS)
---	------------

Ring Message Wait Period

It is not recommended that you change this timer from default.

Ring Message Wait Period	150 (750mS)
---------------------------------	-------------

Doorphones and Door Lock Relay Contacts

You can connect an NEC Doorphone unit to either extension ports 6 or 7 of the IP7WW-308U-A1 card (these ports can be either analogue telephone, Doorphone or External sensor). The port is setup by hardware links on the IP7WW-308U-A1 card, refer to the Quick Install Guide for MOH and External Audio for details of

Go to the Chassis View to check the port assignment.

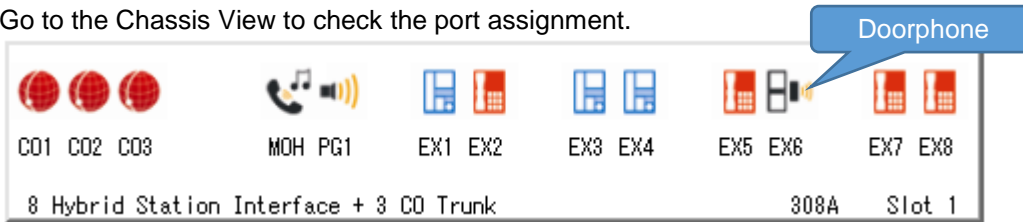

Then click on the port you've assigned EX6 to show the Properties pane for doorphones, you can then name the doorphone and assign the phones that will ring in each mode.

What to do if you make errors within the SL2100 Configuration

Errors that break configuration rules will be highlighted when you click the Apply button. The errors will usually show red or you will see a pop-up message depending which area you are configuring. Enter the correct value and re-apply. Then Upload your changes to the SL2100 and re-test.

Tip - Press F1 to get help within PCPro.

If you can't locate your errors within PCPro then you may need to default the SL2100 back to factory defaults and run the Initial Setup wizard again (this will only take a few minutes).

- Before doing this, download the current SL2100 configuration with PCPro and save the file to your PC, you may then be able to copy and paste the majority of your changes back in, eg the non-configuration effecting items like extension names, speed dials, programmable function keys etc.